



NECTA

USB3 line scan camera

NECTA series



NECTA family of line scan CMOS USB3 cameras provides high scan speed and quick system integration.

Ultra-fast acquisition rate, extremely reduced dimensions and rugged design make NECTA cameras suitable for highly demanding applications: automated optical inspection, high performance sorting systems, industrial metrology, spectrometry, web inspection and more.

NECTA is available with single and dual line AMS Dragster CMOS sensors in 2K, 4K and 8K resolution. It provides on-board color reconstruction with compact dimensions and rugged design, available with C-mount or F-mount lens adapters.

Even beyond

Alkeria development team is also deeply focused on full-custom camera products.

If you need more from your NECTA camera, we can implement smarter hardware and extra firmware features for you. Depending on volumes, we can design your custom camera to protect your IP, differentiate your products and let you gain market share over competitors. If you have been discouraged with custom designs, give us a call: you'll be surprised.

Features

USB3 interface

Up to 5 Gbps USB3 interface allows easy interface to your PC, eliminating expensive frame-grabbers and bulky cables while keeping highest performances.

Tiny rugged design

Small, ultra-lightweight, rugged aluminum machined high precision case allows maximum installation flexibility even in space constrained environments.

Ultra-low power

Latest technology electronics achieves lowest power consumption ever (below 3W for all models).

CMOS technology

AMS Dragster CMOS sensors, color and monochrome, featuring 12 bit A/D converter, up to 8192 pixels, up to 95000 lines/s.

Triple programmable LUTs

Independent LUTs (one for each color) allow easy color thresholding, filtering and calibration for color-critical applications.

Smart Data

Embedded timestamp, trigger counters, encoder position at line, latched input status and input change detection allow perfect image-to-real-world pairing.

Versatile I/O

With 2 inputs and 2 outputs and 1 bidirectional I/O, NECTA series offers unprecedented flexibility for interfacing to outer world signals: line/frame triggering, direct encoder readout and strobed lighting have never been so easy.

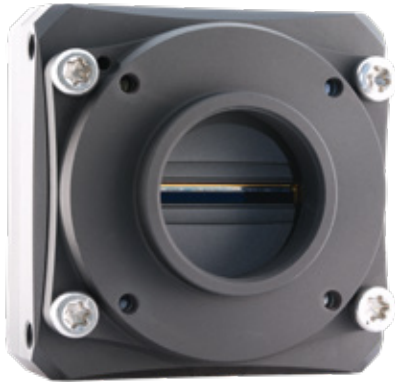

Lens adapters

Vision system performances rely on many factors: one of these is lens quality. There are many lenses currently on the market, with different specifications and price levels: every application needs its very own lens.

We know that in Alkeria, so we decided to equip NECTA with specific C-mount and F-mount lens adapter: they give our customers the perfect flexibility in choosing best optics for their applications.



C-mount

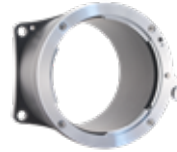

F-mount

Interfacing

USB3

Cost-effective, wide-spread, highly performant, plug&play, directly powered by the PC. All of these perks make USB3 the right choice for cameras intended to be ready out-of-the-box.

I/O

NECTA provides a versatile I/O interface to control external devices such as strobe lights, encoders, etc. 2 input lines with direct encoder interface, 2 output lines and 1 input/output (RS422, RS644 LVDS, LVTTTL). Its multipurpose I/O connector provides user I/O, line/frame triggering and direct encoder interface.



HALCON
COMPATIBLE

COGNEX
COMPATIBLE

Vision libraries

Image processing libraries represent the most flexible way of developing vision applications: these systems provide a complete range of powerful vision analysis tools, as well as the possibility to develop tailor-made algorithms and functionality to address specific application needs.

That's why our cameras are totally compatible with the major vision libraries, such as MVTech Halcon or COGNEX VisionPro.

Want to use your own code instead?

Our cameras come with a comprehensive SDK for Windows and Linux featuring a sample player for live view and setting of the camera, and a rich list of code samples in C# and C++ (WIN32 and Qt).

MODEL	N2K-7	N2K2-7	N2K2-7C	N4K-3	N4K-7	N4K2-7	N4K2-7C	N8K-3
Resolution	2K	2K	2K	4K	4K	4K	4K	8K
Resolution (wxh)	2048 x 1	2048 x 2	2048 x 2	4096 x 1	4096 x 1	4096 x 2	4096 x 2	8192 x 1
Pixel Size	7 x 7 μm^2	7 x 7 μm^2	7 x 7 μm^2	3.5 x 3.5 μm^2	7 x 7 μm^2	7 x 7 μm^2	7 x 7 μm^2	3.5 x 3.5 μm^2
Color mode	BW	BW	Color	BW	BW	BW	Color	BW
C-mount adapter	●	●	●	●	○	○	○	○
F-mount adapter	●	●	●	●	●	●	●	●
Shutter Control	1.3 μs ÷ 100 ms, 100 ns per step							
Line Rate	Up to 95 kHz (MONO8)							
Pixel Format	RGB 24 bit, YUV 4:2:2, MONO8, MONO16, RAW16							
A / D Conversion	Up to 12 bit							
Synchronization	External trigger, software trigger							
Readout	Normal, AOI, binning							
Power Supply	< 3 W, powered by USB3 interface							
Inputs / Outputs	2 in (direct encoder interface), 2 out and 1 I/O (RS422, RS644 LVDS, LVTTTL)							
Interface	USB 3.1 Gen 1							
Weight	96 g (without additional lens adapter)							
Dimensions	56 mm x 56 mm x 19 mm - (L x W x D) camera only							
Conformity	CE, RoHS, FCC/IC							
Main Controls	Shutter, contrast, gain, LUT and gamma correction, white balance, line delay, DSNU/PRNU correction, black level offset calibration							
Operative Temp	0 ÷ 50 °C							

This chart shows all technical specifications of the current NECTA product line.

To know more about specifications and prices, please contact our Sales department at sales@alkeria.com: we'll help you finding the right camera for your application.

Technical specifications

Sensors specifications

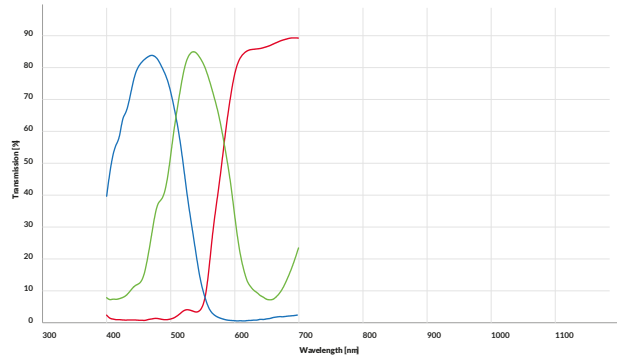
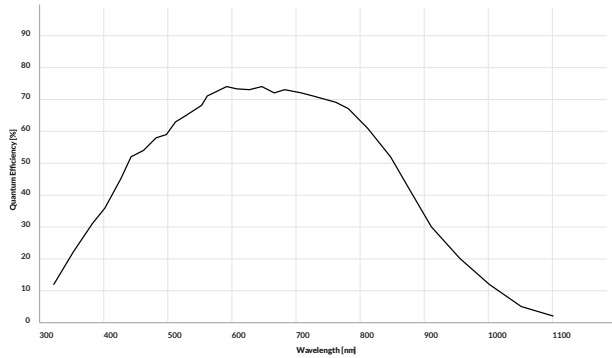

Mechanical specifications

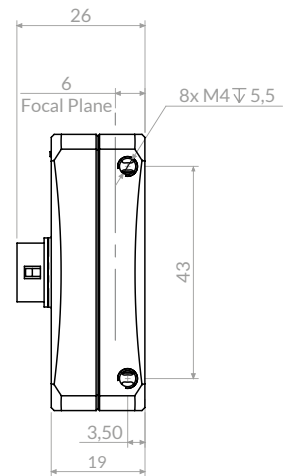
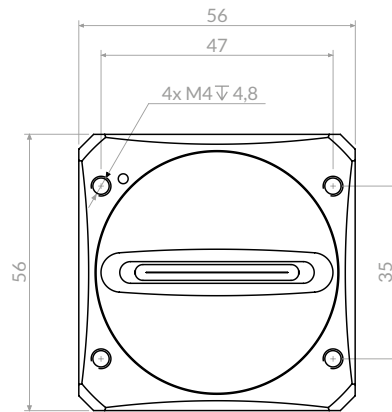
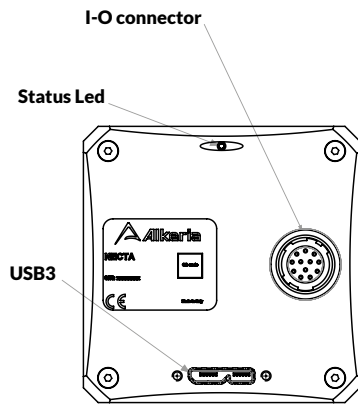

All dimensions are expressed in millimeters.
Camera specifications are subject to change without notice.
Sensor specifications (monochrome and color) are taken from the data sheet of the manufacturer.

Rev.01/2020
©2020 Alkeria srl - all rights reserved
All trademarks are the property of their respective holders



Alkeria

via Giuntini, 25 - int.36

56021 Cascina (PI) - ITALY

www.alkeria.com